

UNIXPCI

HARDWARE &
SOFTWARE
USER'S MANUAL

4/8 Ports Industrial Serial Board for PCI bus
with external connectivity box

RS232
RS422
Isolated RS232
Isolated RS422/RS485
0-20 mA current loop
TTL



ACKSYS Communications & Systems

www.acksys.fr
support@acksys.fr
sales@acksys.fr

June 2007 (Release A.7)
DTUS023

UNXPCI

HARDWARE & SOFTWARE USER'S MANUAL

COPYRIGHT ©ACKSYS 2002-2006

This document contains information that is protected by copyright.

No part of this publication may be reproduced, transcribed, stored on any computer system or other system, translated into any language or into any computer language without prior written permission from ACKSYS, Z.A. Val joyeux – 10 rue des entrepreneurs 78450 Villepreux – France

REGISTERED TRADEMARKS ®

- *ACKSYS* is a registered trademark of *ACKSYS*.
- Windows NT, Windows 95, Windows 98, Windows Me, Windows 2000, Windows XP and Windows Vista are registered trademarks of *MICROSOFT*.

NOTICE

ACKSYS provides this documentation “as is” without warranty of any kind. In no event shall ACKSYS be help responsible for the profitability and conformity of the hardware compared to the user’s requirements.

ACKSYS shall not be held responsible for any errors that might be contained in this document, nor for any damages of any amount that the supply, operation or use of this equipment may entail.

ACKSYS may revise this document from time to time, or change its contents, without notice.

TABLE OF CONTENTS

1. INTRODUCTION	4
2. UNXPCI Board	5
2.1 Synoptic	6
2.2 Pinout of the output connector	7
3. Connection box UNXBP-232	9
3.1 Configuration	10
3.2 Pinout	10
3.3 Cable wiring recommendations.....	11
4. Connection box UNXBP-422	12
4.1 Configuration	13
4.2 Pinout	13
4.3 Cable wiring recommendations.....	14
5. Connection box UNXBP-232-422	14
6. Connection box UNXBPMR.....	15
6.1 MR232ISO interface module	16
6.1.1 Main characteristics.....	16
6.1.2 Configuration	17
6.1.3 Pinout	18
6.2 MR400ISO interface module	19
6.2.1 Main characteristics.....	19
6.2.2 Configuration	20
6.2.3 Pinout	21
6.3 MRBdc interface module	22
6.3.1 Main characteristics.....	22
6.3.2 Configuration	23
6.3.3 Pinout	24
7. INSTALLING THE UNXPCI BOARD	25
8. INSTALLING THE ACKSYS DRIVER FOR WINDOWS	26
8.1 Windows 9x, millennium device driver installation.....	26
8.2 Windows NT device driver installation.....	28
8.3 Windows 2000 / XP /Vista device driver installation	30
8.3.1 Properties of all the communications ports	30
9. INSTALLING THE ACKSYS DRIVER FOR LINUX KERNEL 2.2	35
9.1 Using RS485 mode under Linux	36
10. TROUBLESHOOTING GUIDE.....	37
11. Dimensions & consumptions	38

1. INTRODUCTION

INDUSTRIAL SERIAL COMMUNICATION BOARD, 4 OR 8 CHANNELS, WITH PCI PLUG & PLAY FEATURES

UNXPCI card offers a reliable and very high performance solution for communication applications in industrial environment which need:

- High-speed serial links,
- Versatile interface (RS232, RS422, RS485, TTL...)

The UNXPCI complies with the PCI Specification 2.1 or greater, which makes it easy to install (no jumper or switch for IRQ and I/O base address). All the board resources are automatically assigned by the PCI BIOS during the power-up of the P.C.

The board is shipped with Windows drivers (95, 98, Me, NT 3.51/4.0, 2000, XP, Vista(32 bits)) and Linux drivers. Others drivers are supported by ACKSYS and can be shipped on request.

Several UNXPCI cards can cohabit within a same machine to carry out 8, 16, 24 or 32 ports configurations.

2. UNXPCI Board

- 4 or 8 asynchronous serial communication ports, with D-SUB connectors on an external connection box.
- Advanced communication functions :
 - Automatic RS485 turn-around
 - Flow control (hard/soft) handled by hardware
 - Enhanced baud rate generator for non-standard speeds
 - 128 bytes deep FIFO per transmitter and receiver
 - RS422 baud rate up to 1.8 Mbps with standard 29.4912 MHz oscillator and up to 3.75 Mbps with optional 60 MHz oscillator.
- Slave PCI 5V signaling interface 2.1 or greater
- Polling Register (image of the eight interruption lines of each UART)
- Programmable electrical interface: this mechanism will be used to configure the future connection boxes (electrical interface flavor, test mode...).
- 4 input signals allow the identification of the connection box (BPID0 to BPID3)
- 16 output signals allow the configuration of the connection box (CFG00 to CFG15).
- 2 independent base addresses specified in PCI registers BAR0 & BAR1.
 - BAR0: Base address for UNXPCI configuration registers (7 bytes)
 - BAR1: Base Address for UNXPCI serial ports 1 to 8: 8x8 bytes = 64 (40H)
Port addresses are consecutive

The details of each register can be supplied upon request from customers who want to develop a device driver.

2.1 Synoptic

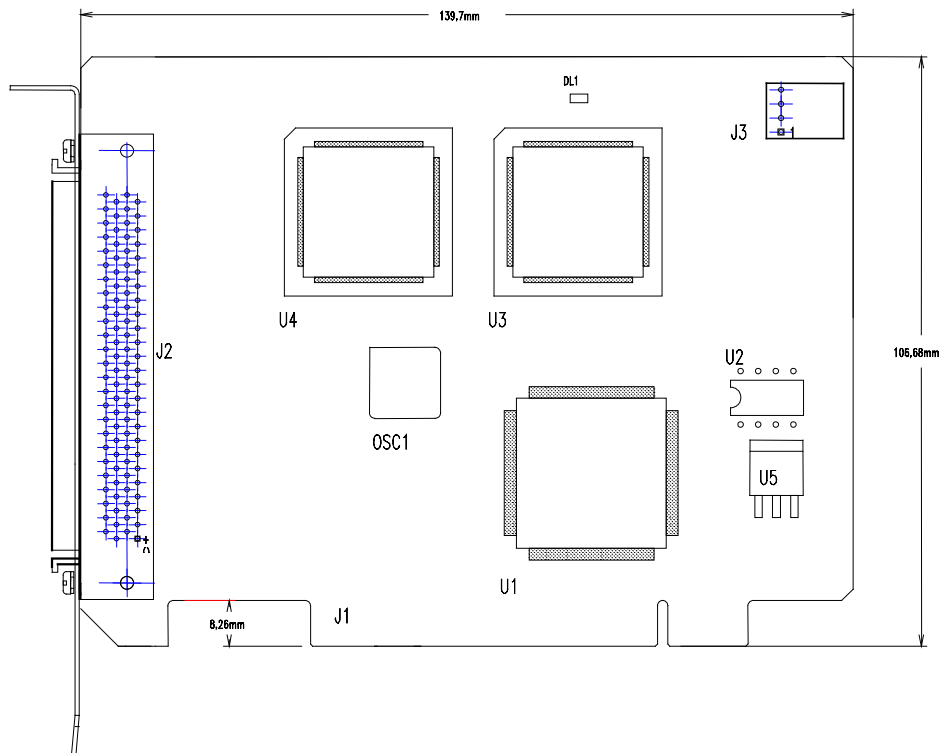

- J1:** PCI connector (5V signaling only)
- J2:** 100 pins connector to connect external box like UNXBP
- J3:** Power connector
- OSC:** 29.4912 MHz oscillator¹ for UARTs
- U1:** PCI interface and logic decoding
- U3/U4:** Quad enhanced UARTs 16C550 compatible

¹ Others oscillator values are available (60 MHz for very high speed serial link, 1,8432 MHz for full compatibility with standard communication ports...)

2.2 Pinout of the output connector

Solder side

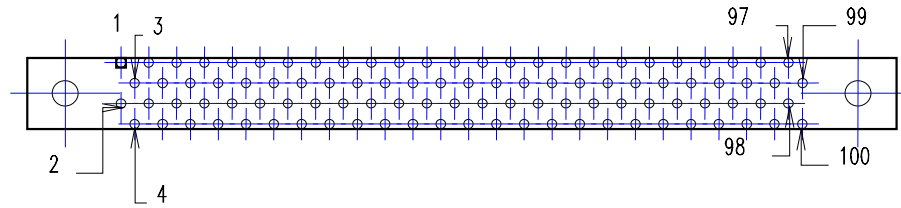

Rear view

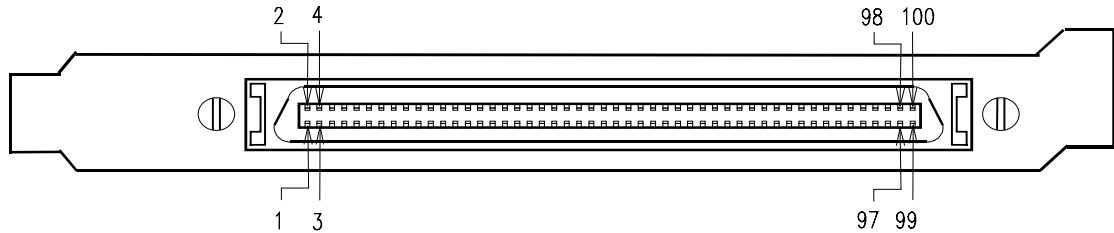

The external metallic frame is connected to the protected earth of the board.

Each signal of the connector is **TTL level compatible**.

Pin N°	Direction	Description
1	I	/DCD Channel 1
2	I	/RI Channel 1
3	I	/DSR Channel 1
4	I	/CTS Channel 1
5	O	TXD Channel 1
6	O	/DTR Channel 1
7	O	/RTS Channel 1
8	I	GND
9	I	RXD Channel 1
10	O	CFG00
11	I	RXD Channel 2
12	O	TXD Channel 2
13	O	/RTS Channel 2
14	I	/CTS Channel 2
15	I	/DCD Channel 2
16	I	/RI Channel 2
17	I	/DSR Channel 2
18	O	CFG01
19	O	/DTR Channel 2
20	I	GND
21	I	RXD Channel 3
22	O	TXD Channel 3
23	O	/RTS Channel 3
24	O	/DTR Channel 3
25	I	/CTS Channel 3

Pin N°	Direction	Description
26	I	/RI Channel 3
27	I	/DCD Channel 3
28	O	CFG02
29	I	/DSR Channel 3
30	I	GND
31	I	RXD Channel 4
32	O	+12V
33	O	TXD Channel 4
34	O	CFG03
35	O	/RTS4
36	O	-12V
37	O	/DTR Channel 4
38	I	/CTS Channel 4
39	I	/DSR Channel 4
40	I	/DCD Channel 4
41	O	+5V
42	O	+5V
43	I	/RI Channel 4
44	I	BPID0
45	I	BPID1
46	O	CFG04
47	O	CFG05
48	O	CFG06
49	O	CFG07
50	I	GND

Pin N°	Direction	Description
51	I	/DCD Channel 5
52	I	/RI5
53	I	/DSR Channel 5
54	I	/CTS Channel 5
55	O	TXD Channel 5
56	O	/DTR Channel 5
57	O	/RTS Channel 5
58	I	GND
59	I	RXD Channel 5
60	O	CFG08
61	I	RXD Channel 6
62	O	TXD Channel 6
63	O	/RTS Channel 6
64	I	/CTS Channel 6
65	I	/DCD Channel 6
66	I	/RI Channel 6
67	I	/DSR Channel 6
68	O	CFG09
69	O	/DTR Channel 6
70	I	GND
71	I	RXD Channel 7
72	O	TXD Channel 7
73	O	/RTS Channel 7
74	O	/DSR Channel 7
75	I	/CTS Channel 7

Pin N°	Direction	Description
76	I	/RI Channel 7
77	I	/DCD Channel 7
78	O	CFG10
79	I	/DSR Channel 7
80	I	GND
81	I	RXD Channel 8
82	O	+12V
83	O	TXD Channel 8
84	O	CFG11
85	O	/RTS Channel 8
86	O	-12V
87	O	/DTR Channel 8
88	I	/CTS Channel 8
89	I	/DSR Channel 8
90	I	/DCD Channel 8
91	O	+5V
92	O	+5V
93	I	/RI Channel 8
94	I	BPID2
95	I	BPID3
96	O	CFG12
97	O	CFG13
98	O	CFG14
99	O	CFG15
100	I	GND

BPIDxx & CFGxx signals are reserved signals.

3. Connection box UNXBP-232

The UNXBP-232 device is a fully independent sub-assembly of the UNXPCI card. It includes all the signal amplification system to support the RS232 standards.

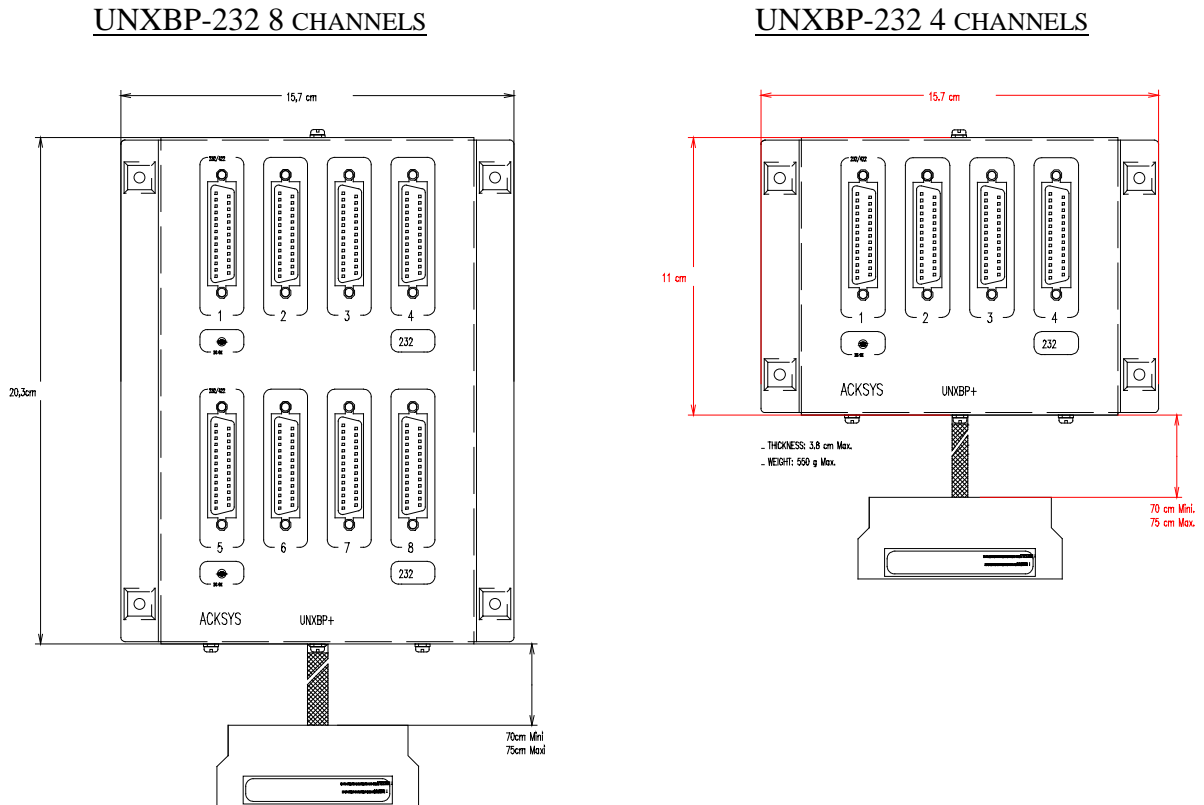

UNXPCI-232-4M: 4 RS232 (male connectors) channels with channel 1 switchable to RS422

UNXPCI-232-4F: 4 RS232 (female connectors) channels with channel 1 switchable to RS422

UNXPCI-232-8M: 8 RS232 channels (male connectors) with channels 1 & 5 switchable to RS422

UNXBP-232 devices offer an exceptional protection against overvoltages and electrostatic discharges (ESD). These protections are enforced on each signal by devices filtering the tension surges dangerous for electronics.

Associated with the shielded cable, these safety devices ensure to the UNXPCI a great reliability a great longevity, a very reduced emission of electromagnetic radiation as well as a great immunity to external interference.

All these elements make the UNXPCI card the ideal tool for communication applications in disturbed industrial environment.

In the event of significant overload on the communication lines (lightning, direct connection to mains, etc.), the safety devices self-destruct in order to effectively protect card UNXPCI and the host system.

3.1 Configuration

To switch channels 1 or 5 from RS232 to RS422, set the switches under the UNXBP for the corresponding channel according to the picture below. The RS422 termination resistor (121 Ohms) is automatically connected in RS422 mode on each receiver.

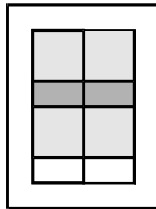

RS232 mode
Hidden dots

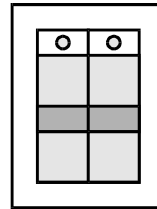

RS422 mode
Visible dots

3.2 Pinout

The table below gives the output connector pinout.

25 pins D-SUB male or female connector UNXBP-232-4 exists with male or female output connectors. UNXBP-232-8 only exists with male output connectors. Notice that ports 1 and 5 can be switched in RS422 mode.				
n°	Function		n°	Function
	PG		14	Not connected
2	TXD		15	Not connected
3	RXD		16	Not connected
4	RTS		17	Not connected
5	CTS		18	Not connected
6	DSR		19	Not connected
7	GND 0V		20	DTR
8	CD		21	RxB (-RX) ⁽¹⁾
9	+12V _{DC}		22	RI
10	-12V _{DC}		23	RxA (+RX) ⁽¹⁾
11	Not connected		24	Not connected
12	TxB (-TX) ⁽¹⁾		25	Not connected
13	TxA (+TX) ⁽¹⁾			

(1) The TxA, TxB, RxA and RxB signals are available only on ports 1 and 5 in RS422 mode

3.3 Cable wiring recommendations

The UNXBP is a RS232 DTE device, so
to connect it to a DTE device, use a null-modem cable
to connect it to a DCE device, use a straight through cable

It is highly recommended to check attribution of pins 9 and 10 on the connector devices connected to the UNXBP; indeed, some modems use these pins to supply their electronics. In this case, we advise you not to connect these pins or to check that the consumption of the modem is compatible with the available current (750 mA MAX). A LED, when lit, shows that the UNXBP is correctly fed by the system. This indicator can stay off for the following reasons:

- Bad cable connection
- Breakdown on +12V and -12V voltages of the system
- Short-circuit on a 25 D-SUB connector
- Overload of the power voltages on the 25 D-SUB connector
- Failure of the LED

In the event of accidental short-circuit on D-SUB connectors it is recommended to power down the system and to detect the cause of the short-circuit. Be warned that the restartable thermal fuses protection will not allow to turn back on the power supply in the connection box, until the power supply has been turned off for at least 20 seconds.

4. Connection box UNXBP-422

The UNXBP-422 device is a fully independent sub-assembly of the UNXPCI card. It includes all the signal amplification system to support the RS422 standards.

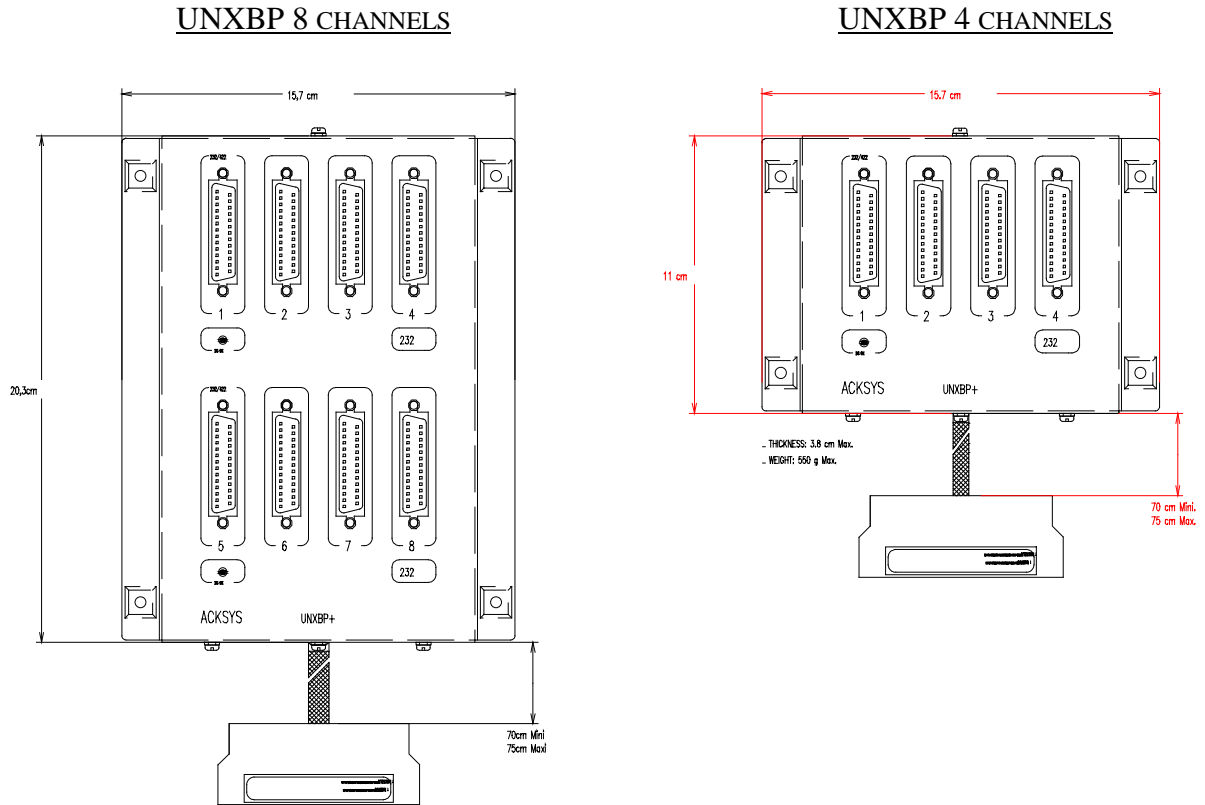

UNXPCI-422-4: 4 RS422 channels with channel 1 programmable in RS232

UNXPCI-422-8: 8 RS422 channels with channels 1 & 5 programmable in RS232

UNXBP devices offer an exceptional protection against overvoltages and electrostatic discharges (ESD). This protection is enforced on each signal by devices filtering the tension surges dangerous for electronics.

Associated with the shielded cable, these safety devices ensure to the UNXPCI a great reliability a great longevity, a very reduced emission of electromagnetic radiation as well as a great immunity to external interference.

All these elements make the UNXPCI card the ideal tool for communication applications in disturbed industrial environment.

In the event of significant overload on the communication lines (lightning, direct connection to mains, etc.), the safety devices self-destruct in order to effectively protect card UNXPCI and the host system.

4.1 Configuration

To switch channels 1 or 5 from RS422 to RS232, set the switches under the UNXBP for the corresponding channel according to the illustration below.

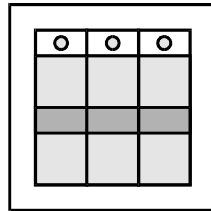

RS422 mode
Visible dots

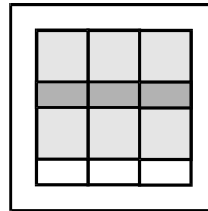

RS232 mode
Hidden dots

4.2 Pinout

The table below gives output connector pinout.

25 pins D-SUB female connector				
Ports 1 and 5 can be switched in RS232 mode.				
n°	Function		n°	Function
	PG		14	Not connected
2	TXD ⁽¹⁾		15	Not connected
3	RXD ⁽¹⁾		16	Not connected
4	RTS ⁽¹⁾		17	Not connected
5	CTS ⁽¹⁾		18	Not connected
6	DSR ⁽¹⁾		19	Not connected
7	GND 0V		20	DTR ⁽¹⁾
8	CD ⁽¹⁾		21	RxB (-Rx)
9	+5V _{DC}		22	RI ⁽¹⁾
10	-12V _{DC}		23	RxA (+Rx)
11	Not connected		24	Not connected
12	TxB (-Tx)		25	Not connected
13	TxA (+Tx)			

(1) Signals TXD, RXD, RTS, CTS, DSR, DTR, RI are available only on ports 1 & 5 in RS232 mode.

4.3 Cable wiring recommendations

It is highly recommended to check attribution of pins 9 and 10 on the connector devices connected to the UNXBP; indeed, some modems use these pins to supply their electronics. In this case, we advise you not to connect these pins or to check that the consumption of the modem is compatible with the available current (750 mA MAX). A LED shows, when lit, that the UNXBP is correctly fed by the system. This indicator can stay off for the following reasons:

- Bad cable connection
- Breakdown on +12V and -12V voltages of the system
- Short-circuit on a 25 D-SUB connector
- Overload of the power voltages on the 25 D-SUB connector
- Failure of the LED

In the event of accidental short-circuit on D-SUB connectors it is recommended to power down the system and to detect the cause of the short-circuit. Be warned that the restartable thermal fuses protection will not allow to turn back on the power supply in the connection box, until the power supply has been turned off for at least 20 seconds.

5. Connection box UNXBP-232-422

The UNXBP-232-422 device only exists with 8 channels. The first four channels are compatible with the UNXBP-232-4M device and the last four are compatible with the UNXBP-422-4 device.

6. Connection box UNXBPMR

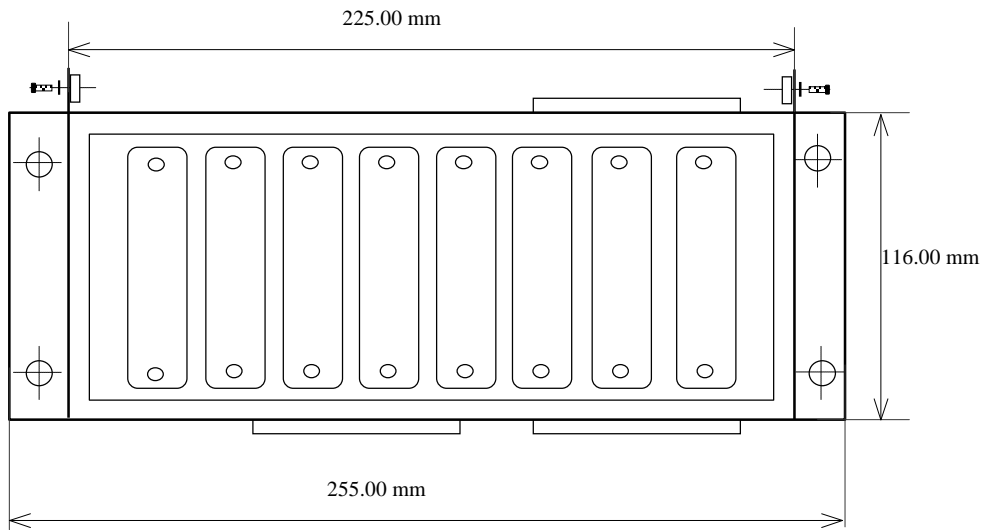

The UNXBPMR device is a fully independent sub-assembly of the UNXPCI card. It includes all the amplification system to support RS232, RS422, RS485 and 0-20 mA current loop standards. It is composed of a 8-positions pack with 4 or 8 interface modules. You can choose a different interface module for each line.

The following interface modules are available:

- MR232ISO interface module: RS232, isolation up to 2KV
- MR400ISO interface module: RS422/RS485, isolation up to 2KV
- MRBdc interface module: 0-20mA current loop, isolation up to 2KV

6.1 MR232ISO interface module

The MR232ISO module supplies a RS232 physical interface with a galvanic isolation.

6.1.1 Main characteristics

Interface	RS232 DTE
Galvanic isolation	2000 V _{eff}
Permanently converted signals	Tx, Rx
Configurable converted output signals	By switches: one of RTS or DTR or TXCLK
Configurable converted input signals	By switches: one of CTS or DCD or RI or DSR or RXCLK or TXCLK-I
Max. bit rate	230 Kbps
Visualization	POWER TX (TX Signal) RX (RX Signal) CtrlOUT (Output signal) CtrlIN (Input signal)
High voltage protection	ESD 15 kV, EMI/RFI filtering
Power supply protection	Fast restartable thermal fuse
Output connector	25 pins D-sub female
Consumption	145 mA max

6.1.2 Configuration

Two configuration switches (SW1 and SW2) located on-module are used. To modify the factory settings (RTS/CTS), first unscrew and remove the module.

CONFIGURABLE CONVERTED OUTPUT SIGNAL	SW1	SW2
RTS (factory setting)	<p>on</p> <p>1 2 3 4 5 6 7 8</p>	<p>on</p> <p>1 2 3 4 5 6 7 8</p>
DTR	<p>on</p> <p>1 2 3 4 5 6 7 8</p>	<p>on</p> <p>1 2 3 4 5 6 7 8</p>

CONFIGURABLE CONVERTED INPUT SIGNAL	SW1	SW2
CTS (factory setting)	<p>on</p> <p>1 2 3 4 5 6 7 8</p>	<p>on</p> <p>1 2 3 4 5 6 7 8</p>
DCD	<p>on</p> <p>1 2 3 4 5 6 7 8</p>	<p>on</p> <p>1 2 3 4 5 6 7 8</p>
RI	<p>on</p> <p>1 2 3 4 5 6 7 8</p>	<p>on</p> <p>1 2 3 4 5 6 7 8</p>
DSR	<p>on</p> <p>1 2 3 4 5 6 7 8</p>	<p>on</p> <p>1 2 3 4 5 6 7 8</p>

6.1.3 Pinout

25 pins D-SUB female connector			
Pin N°	Direction	Name	Function
1	I	PGND	Earth
2	O	TXD	Transmitted data
3	I	RXD	Received data
4(*)	O	RTS	Request to send
5(*)	I	CTS	Clear to send
6(*)	I	DSR	Data Set Ready
7	I	GNDI	Isolated ground
8(*)	I	DCD	DCD
9		NC	Not connected
10		NC	Not connected
11		NC	Not connected
12		NC	Not connected
13		NC	Not connected
14		NC	Not connected
15		NC	Not connected
16		NC	Not connected
17		NC	Not connected
18		NC	Not connected
19		NC	Not connected
20(*)	O	DTR	Data Terminal Ready
21		NC	Not connected
22(*)	I	RI	Ring Indicator
23		NC	Not connected
24		NC	Not connected
25	I	GNDI	Isolated ground

I: Input.

O: Output.

(*) Configurable by switches.

6.2 MR400ISO interface module

The MR400ISO module supplies a RS422/485 physical interface with a galvanic isolation.



6.2.1 Main characteristics

Interface	RS422 Master/Slave or RS485
Galvanic isolation	2000 Veff.
Permanently converted signals	Tx, Rx
Configurable converted output signals	By jumper: RTS or TxCLK
Configurable converted input signals	By jumper: CTS or RxCLK
Max. bit rate	5 Mbps
Visualization	POWER TX (TX Signal) RX (RX Signal) RTS (RTS Signal) CTS (CTS Signal)
High voltage protection	ESD 15 kV, EMI/RFI filtering
Power supply protection	Fast restartable thermal fuse
Output connector	9 pins D-sub female
Consumption	100 mA max

6.2.2 Configuration

One external DIP switch selects the electrical interface.

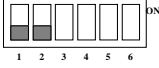
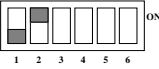
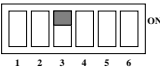
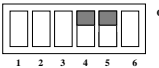
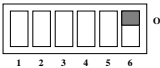
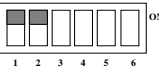
Two internal jumpers select the two input and output command signals.

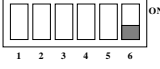
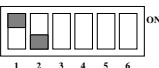
DIP6 SWITCH (Factory setting all OFF)			
Transmission mode	Turnaround ⁽¹⁾	Line polarization	Line termination
RS422 4 wires « Master » 			
RS422 4 wires « Slave » 	By TXD 	YES 	YES 
RS485 2 wires without echo 	By RTS 	NO 	NO 
RS485 2 wires with echo 			

(1) not used in 4 wires mode.

J2 Jumper : Output signal

1-2 : RxCLK
 2-3 : CTS (factory setting)

J3 Jumper : Input signal

1-2 : TxCLK
 2-3 : RTS (factory setting)

6.2.3 Pinout

9 pins D-SUB female connector					
422 mode			485 mode		
Pin N°	Signal	Function	Pin N°	Signal	Function
1	CTSA	CTS or RxClk	1	CTSA	CTS or RxClk
2	RXA (A')	Rx DATA	2	TRXA (AA')	Tx/Rx DATA
3	TXA (A)	Tx DATA	3	Res.	Reserved
4	RTSA	RTS or TxClk	4	RTSA	RTS or TxClk
5	GND	Ground	5	GND	Ground
6	CTSB	CTS or RxClk	6	CTSB	CTS or RxClk
7	TXB (B)	Tx DATA	7	Res.	Reserved
8	RXB (B')	Rx DATA	8	TRXB (BB')	Tx/Rx DATA
9	RTSB	RTS or TxClk	9	RTSB	RTS or TxClk

6.3 MRBdc interface module

The MRBdc module supplies a 0-20mA current loop physical interface with a galvanic isolation.

6.3.1 Main characteristics

Interface	0-20mA current loop
Galvanic isolation	2000 Veff
Permanently converted signals	Tx, Rx
Current in idle state	Configurable with jumper JP1
Active or passive loop	Configurable by specific wiring of the output connector
Max. bit rate	57.6 Kbps
Visualization	POWER TX (TX Signal) RX (RX Signal)
Output connector	25 pins D-sub female
Consumption	NC

6.3.2 Configuration

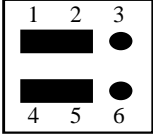
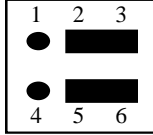
JP1: Current loop in idle (MARK) state	
Current present in idle (MARK) state $(I_{bc} > 12\text{mA})$	No current in loop in idle (MARK) state $(I_{bc} < 3\text{mA})$
 JP 1	 JP 1 (Factory setting)

25 D-SUB WIRING: ACTIVE or PASSIVE mode for TX and TX loop		
MODE	TX LOOP	RX LOOP
ACTIVE	STRAP 6-7 & 21-22	STRAP 10-11 & 24-25
PASSIVE	STRAP 21-20	STRAP 24-23

6.3.3 Pinout

25 pins D-SUB female connector		
PIN N°	NAME	FUNCTION
1	PGND	Protective ground
2	NC	Not Connected
3	NC	Not Connected
4	NC	Not Connected
5	NC	Not Connected
6	VBCTX	USED FOR CONFIGURATION
7	VBCTX1	USED FOR CONFIGURATION
8	+TX	Tx current loop
9	-TX	Tx current loop
10	VBCRX	USED FOR CONFIGURATION
11	VBCRX1	USED FOR CONFIGURATION
12	+RX	Rx current loop
13	-RX	Rx current loop
14	NC	Not Connected
15	NC	Not Connected
16	NC	Not Connected
17	NC	Not Connected
18	NC	Not Connected
19	NC	Not Connected
20	-TXR1	USED FOR CONFIGURATION
21	-TXR	USED FOR CONFIGURATION
22	GNDI	USED FOR CONFIGURATION
23	-RXR1	USED FOR CONFIGURATION
24	RXR	USED FOR CONFIGURATION
25	GNDI	USED FOR CONFIGURATION

7. INSTALLING THE UNXPCI BOARD

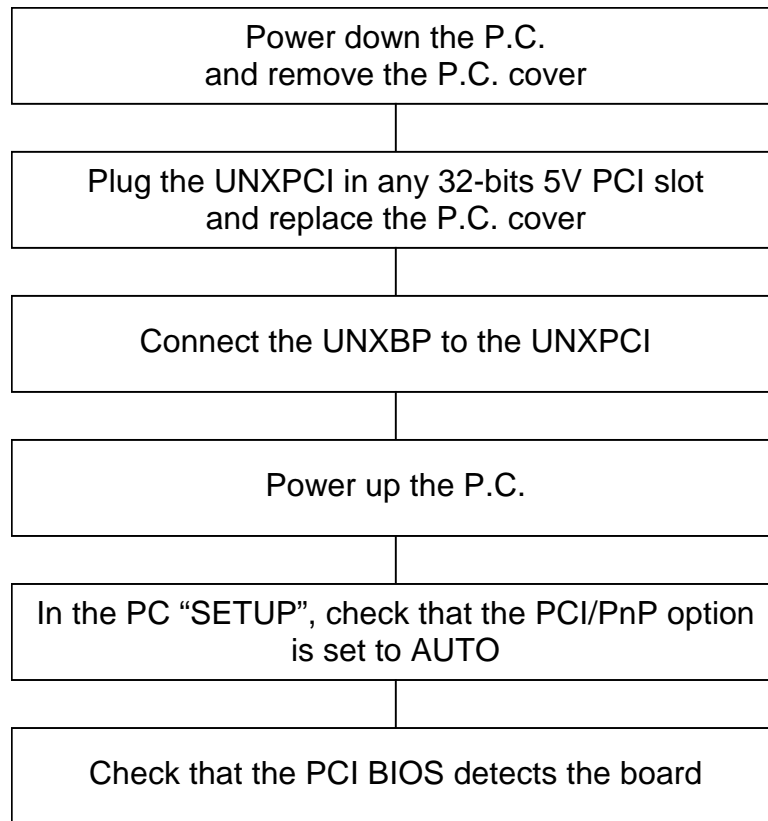

In case of problems, refer to the "troubleshooting guide" section.

8. INSTALLING THE ACKSYS DRIVER FOR WINDOWS

At first, install the UNXPCI board (see previous section), and start Windows.

Notice, for this is a PCI board, once the board is plugged or removed, the configuration will be automatically updated.

8.1 Windows 9x, millennium device driver installation

Under Windows 9x and Millennium, an installation wizard is automatically launched during the first installation.

The *Add new hardware* wizard will automatically run the first time the card is installed, as soon as the card is detected. Follow the wizard instructions.

After the driver is installed, the system properties will be updated automatically by adding

- one multi-function adapter called “UNXPCI 4/8 Ports”
- 4/8 PCI communication ports

Now, the driver installation is complete and successful, you are ready to use the 4/8 add-on PCI communications ports. If you want to add a board while the driver has been already installed, Windows will skip the installation wizard and will install automatically the 4/8 PCI communications ports.

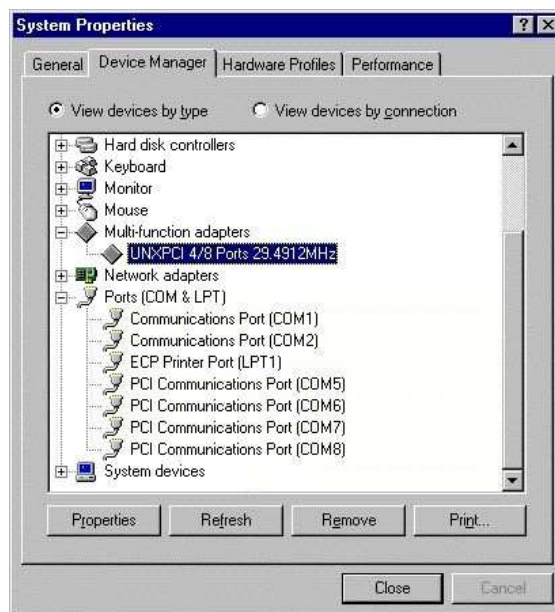

Please, ignore for each PCI communication ports and the multi-function adapter, the conflict between them.

If you change for a board with a different oscillator, edit the **Properties** of the multi-function adapter and follow steps 1 to 5

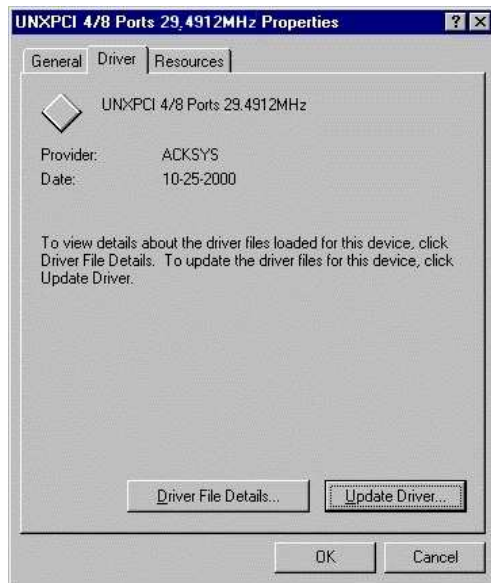

Step1
In the Driver tab, click **Update Driver**



Step2
Click **Next >**



Step3
Click **Next >**



Step 4
Select 'Install one of the other drivers' then click **View List**

Step 5
Now select the board with the correct oscillator. Click **OK** and terminate the installation.

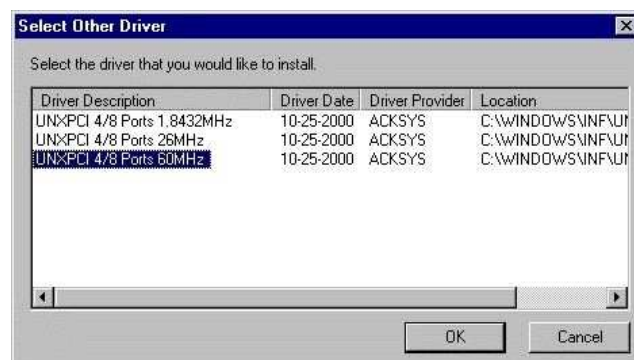

8.2 Windows NT device driver installation

First, install the UNXPCI board, and start Windows NT.

To install the device driver:

Start your P.C and log as administrator

Insert ACKSYS CD

Start the program UNXSETUP from ACKSYS CD

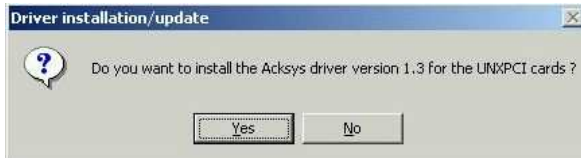

Click on **Yes**

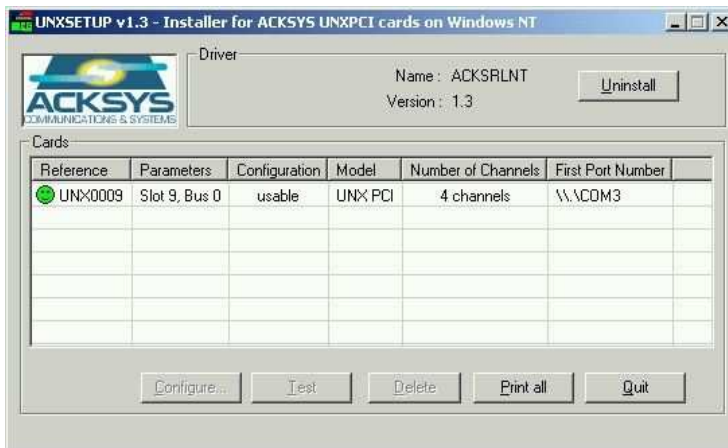

In this window, you see all the UNXPCI boards detected by the driver.

At this time you can directly click on **Quit** to terminate the installation process, or select one board and click on the "**Configure ...**" button to open the ACKSYS UNXPCI Properties window.

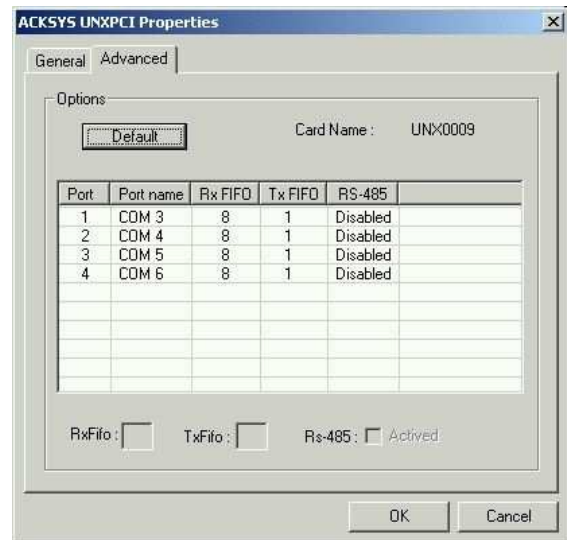
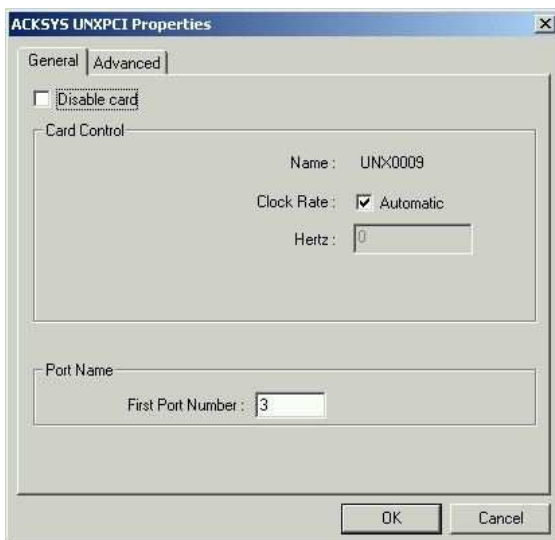

In the ACKSYS UNXPCI windows:

You can disable a card by clicking on the “disable card” check box.

You can assign a COM number to each port by fixing the COM number assigned to the first communication port. By example, if you specify 3 in the field “First Port Number”, the first port is COM3 and all subsequent ports are COM4, COM5, COM6...

You can specify, for each port, the RxFIFO trigger level and TxFIFO size and the RS485 mode.

To remove the device driver and the installed UNXPCI card, start UNXSETUP.EXE and click on the “Uninstall button ...”

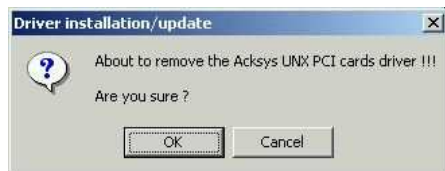
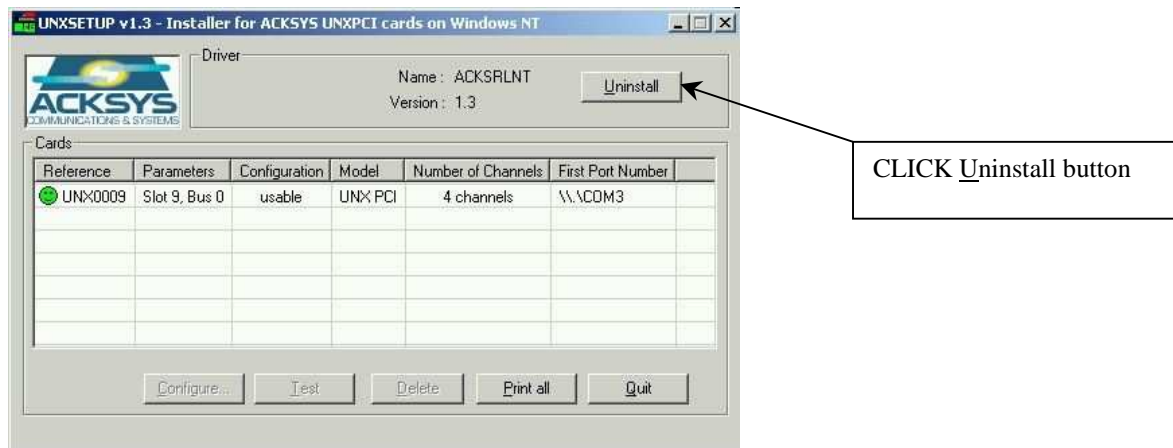

8.3 Windows 2000 / XP /Vista device driver installation

As with Windows 9x or ME, Windows 2000 / XP / Vista(32 bits) automatically detects the UNXPCI card. A hardware installation wizard is automatically run when the system starts up, as soon as the card is detected. To install the device driver, follow the wizard instructions.

NOTE FOR WINDOWS XP AND VISTA : The wizard will announce you that the driver is not certified. Ignore this message in order to continue the installation of the card.

8.3.1 Properties of all the communications ports

The new communications ports are visible in the device manager (control panel/hardware).

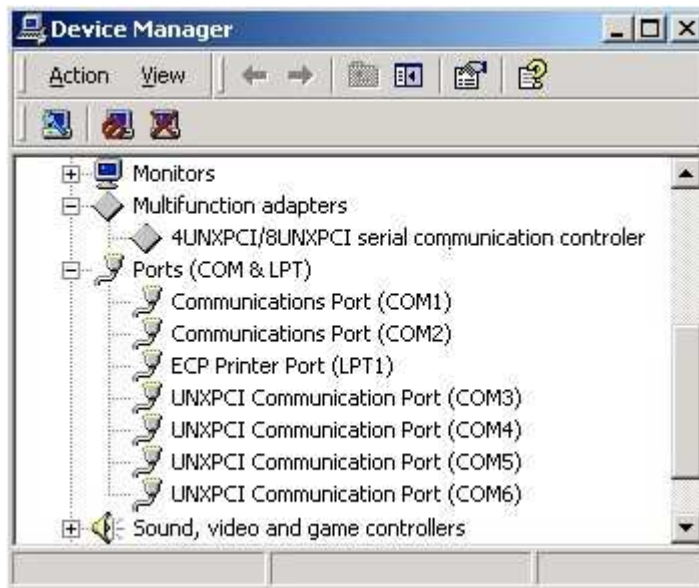

Double-click one of the ports to edit its properties.

The “**Settings**” tab enables the default communications parameters to be defined, as with a standard COM port. It can also be used to define the interface type and automatic line turnaround for RS485.

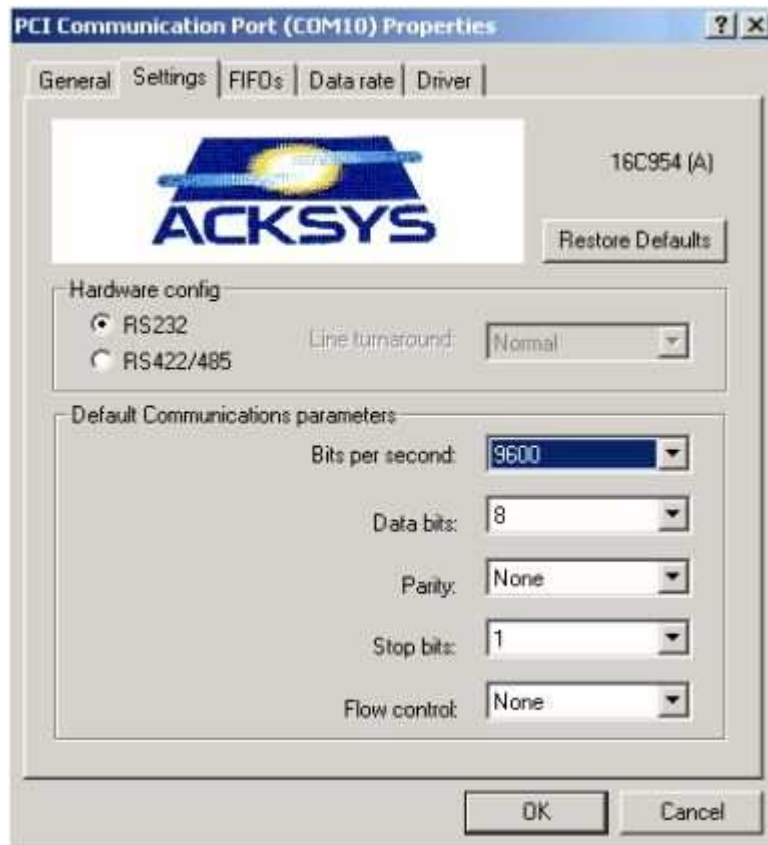

Hardware configuration

RS232: In this mode, the control of hardware flow and the positioning of control signals are enabled by the peripheral driver. Automatic line turnaround is forbidden.

RS422/485: In this mode, the control of hardware flow is forbidden. Automatic line turnaround can be programmed.

Line turnaround

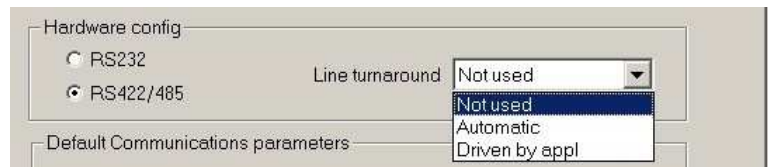

This refers to driving the direction of communication in RS485. If the port is configured as RS422 (pin to pin links), simultaneous transmission and reception (“full duplex”) are enabled, and so the communication direction does not need to be driven. The selected option must be: “**Not used**” – transmission is therefore always enabled.

In RS485 mode, transmission and reception alternate (“half duplex”) and it is therefore necessary to drive a signal indicating whether the line should be transmitting or receiving. When idle (no transactions) the line is receiving; as soon as a character or group of characters needs to be transmitted, the line must be switched into transmission mode: the UNXPCI card uses the DTR signal to carry out this function.

When the “**Driven by application**” option is selected, the application is in charge of controlling the DTR signal. The signal must be asserted before transmission and deasserted when the last character has been transmitted. This method does not allow precise control of the switching time after a transmission is complete.

For more efficient control, or if the application cannot manage the DTR signal, select the “**Automatic**” option: the DTR signal will now be driven automatically by the UART whenever a character is transmitted, guaranteeing an optimal switching time for the communication direction.

***Note:** Driving the communication direction can be necessary in **RS422** mode, when several pieces of equipment are connected to a bus (**master/slave RS422 or RS485 4 wire**). If the port of the UNXPCI card is a “slave” peripheral, it shares its transmission line with the other “slave” peripherals in the network, and must therefore leave it in a state of “high impedance” when it is not transmitting.*

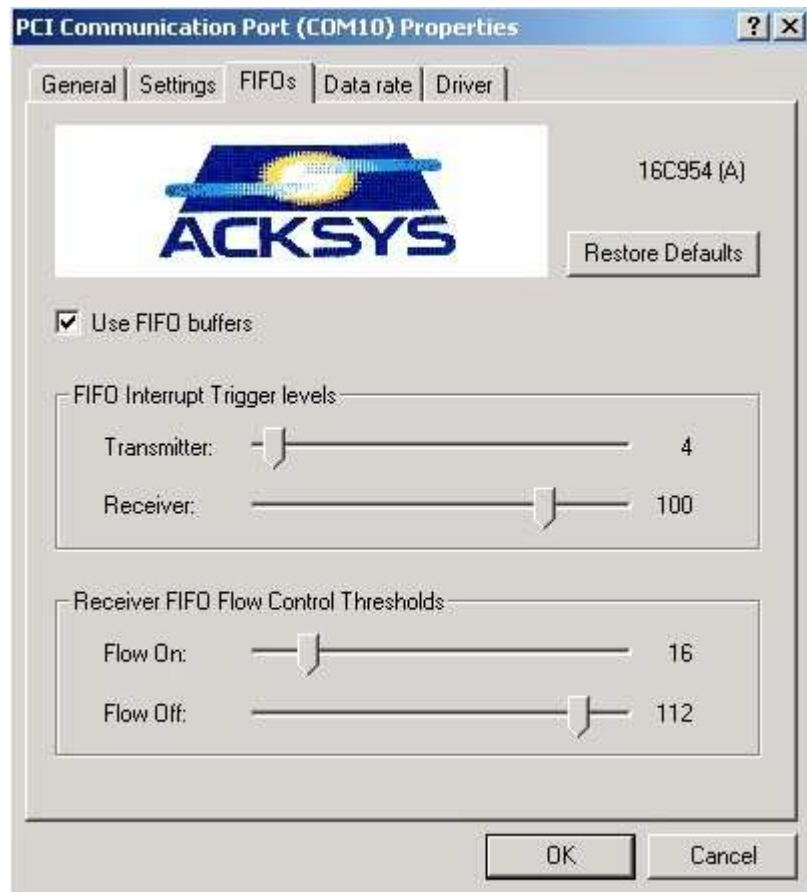

The **FIFOs** tab enables you to set the interrupt trigger levels for transmission and reception according to the number of characters in the respective buffers, as well as the flow control trigger levels. The default values are satisfactory for most traditional applications.

Configuring the interrupt trigger levels:

The value defined using the “Transmitter” cursor gives the level from which a transmitter interrupt will be generated. For example, the default value, 4, indicates that an interrupt will be generated as soon as the number of characters in the transmission buffer drops from 5 to 4. This value should remain low, but it may be advisable to increase it for higher speeds or with slow or overloaded CPUs.

The value defined using the “Receiver” cursor gives the level from which a receive interrupt will be generated. In the case of the default value, the interrupt occurs when the number of characters in the receiver buffer rises from 63 to 64. If the number of characters received is less than the threshold, and does not change during a period corresponding to the time to transmit 4 characters, a time-out interrupt is generated to warn the peripheral’s driver.

In the case of an application transferring large blocks of data, it is advisable to choose high thresholds in order to reduce the number of interrupts and thus the load on the CPU. However, it is not recommended that the maximum values be used, especially when communicating at high speed, in order to avoid reception overwrites and transmission interruptions.

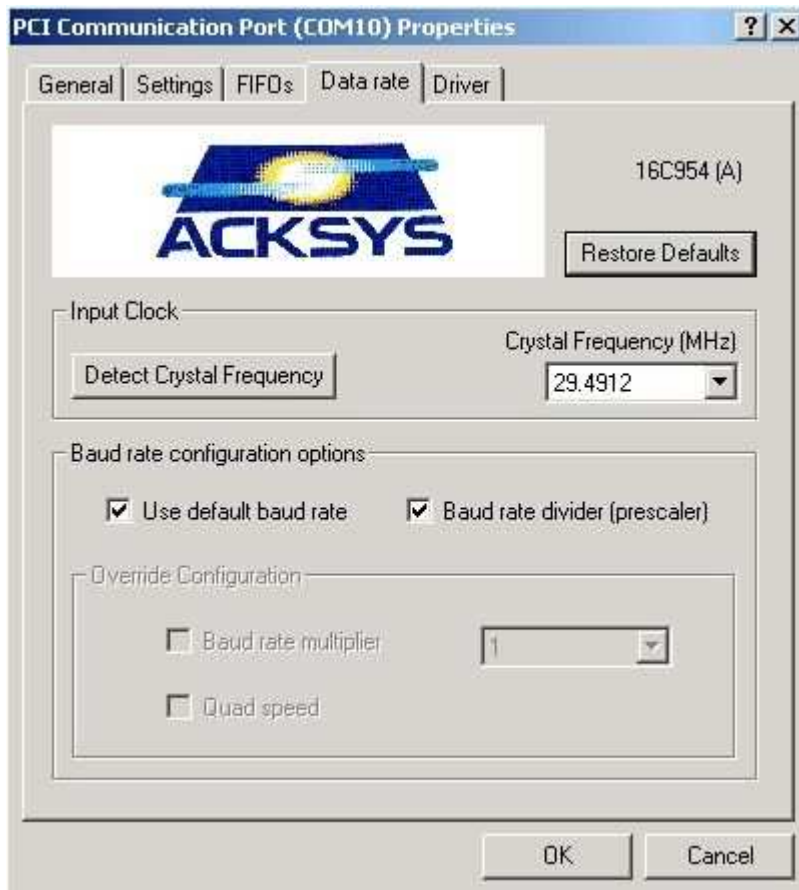

The “**Data Rate**” tab enables you to select the frequency of the oscillator for certain specific models of the UNXPCI cards. The default value is 24.4912 MHz.

- ‘**Use default baud rate**’ option: This should remain selected. It indicates that the communications speed is fixed, as normal, by the Win32 API.
- ‘**Baud rate divider (prescaler)**’ option: this option is active by default, and enables the communications speed to be calculated using a decimal prescaler, enabling better precision for non-standard speeds to be obtained. In this case, the UNXPCI driver calculates parameters that give the best precision in terms of the requested speed. When this option is not selected, the rounding of non-standard speeds is compatible with older cards.
- ‘**Baud rate multiplier**’ option: this functionality cannot be selected when the “Use default baud rate” option is ticked. It enables the multiplication factor chosen in the selection box to be applied to the speed requested by the application. For example, with a factor of 16, when the application requests a speed of 115200 baud, the effective speed will be 1.8432 MHz, thus enabling an application which would otherwise be limited to 115200 baud to work at higher speeds.
- ‘**Quad Speed**’ option: this functionality cannot be selected when the “Use default baud rate” option is ticked. It should not be used for conventional applications, and the tick box should be left clear.

9. INSTALLING THE ACKSYS DRIVER FOR LINUX KERNEL 2.2

The installation procedure has been tested initially using **Linux Mandrake** version **7.2** and version **2.2.17-21** of the kernel. If you have any compatibility problems with other versions of Linux, please contact ACKSYS.

All the programs described below can be found in `/linux/V2.1` on the media supplied.

Installing the module

This type of installation does not require Linux to be recompiled. In addition, it enables the driver to be loaded and unloaded dynamically.

- Copy the file **srllinux.o** into the directory

```
/lib/modules/$(shell uname -r)/misc/
```

- The nodes must be created in the system. To do this, edit the **msmknod** script supplied by ACKSYS, adjust the **MAXPORT** constant according to your card (if you have a 2-port card enter 2, if you have a 4-port card enter 4, etc.) and then run the script. It will create the peripheral files as follows:

<i>Card number</i>	<i>Peripheral number</i>
1	<code>ttyM0-ttyM[MAXPORT-1]</code>
2	<code>ttyM[MAXPORT]-ttyM[2*MAXPORT-1]</code>

- To install the module, just enter `insmod srllinux`
- To stop the module, enter `rmmod srllinux`
- To check that the module has been correctly installed, use the `lsmod` command.

NOTE:

The next time Linux is started up, the module will not run automatically – for this to happen, add the file **rc.ack** in the file **rc.serial**.

If the **rc.serial** file does not exist, create it, adding the line:

```
/etc/rc.d/rc.ack
```

Then edit the file **rc.local**, adding the following line:

```
if [ -f /etc/rc.d/rc.serial ]; then
    sh /etc/rc.d/rc.serial
fi
```

NOTE

If the card's oscillator is not set to 29.4912 MHz, you must add the following option when you install the module:

```
input_clock=[Freq. in Hz].
```

For example, for a 16 MHz oscillator, the command is as follows:

```
insmod srllinux input_clock=16000000
```

9.1 Using RS485 mode under Linux

When one uses a line in RS485 mode, there is the possibility of managing the automatic reversal of way. For that it is necessary to use the iocontrols according to:

- ACKSYS_ENABLE_485_MODE: Validate the function of automatic line control.
- ACKSYS_DISABLE_485_MODE: Function disabling the automatic line control.

These iocontrols take a parameter. The Linux API function making it possible to send the iocontrol to the driver is `ioctl(...)`. This function is to be sent once the communication channel is opened. If you work in RS485 mode, you must not send iocontrol `ACKSYS_DISABLE_485_MODE` before the port is closed, under risk to disturb the operation of the bus.

These constants are defined in the file `iocontrol.h`.

10. TROUBLESHOOTING GUIDE

The UNXPCI board cannot be detected by the BIOS itself.

- Check the PCI/PnP options in the setup program of the motherboard, and set it to AUTO
- Check if the board is correctly plugged in the slot
- Try another slot until you find a good one

The UNXPCI board is not automatically detected by Windows system (except NT)

- Check the first item.
- Check in the Windows system properties if the UNXPCI board is not yet recognized as a standard PCI card or multifunction card, if yes remove the corresponding entry and
- Click refresh button until the installation wizard is launching.
- Reinstall Windows

The communication between the UNXPCI and your equipment is not functioning

- Check the connection between the external device (UNXBPxxx.) and the UNXPCI
- Check the led indicator “DC OK”
- Check the cable wiring
- Check the communication parameters (Speed, parity, number of stop bits, flow control) of each side
- In case of RS422 cable wiring, check the polarity +/- of the data signals both side.
→ Notice that the A signal must have a lower voltage than the B signal in MARK state

If you suspect the board or software might be defective, contact ACKSYS hotline at support@acksys.fr and report your problem in the report form.

11. Dimensions & consumptions

CONSUMPTION				DIMENSIONS in mm
PRODUCT	Voltage in V	Max Cur in mA	Power in W	L x l
UNXPCI-TTL-4	+ 5 +/- 12	60 0	0,3 0	139,7 x 106,68
UNXPCI-TTL-8	+ 5 +/- 12	90 0	0,45 0	
UNXPCI-232-4	+ 5 +/- 12	80 60	0,4 0,72	
UNXPCI-232-8	+ 5 +/- 12	140 120	0,7 1,44	
UNXPCI-422-4	+ 5 +/- 12	210 22	1,05 0,264	
UNXPCI-422-8	+ 5 +/- 12	420 46	2,1 0,552	
UNXBP232-4	+5 +/-12	20 60	0,1 0,720	157 x 110
UNXBP232-8	+5 +/-12	30 120	0,15 1,44	203 x 157
UNXBP422-4	+5 +/-12	150 22	0,75 0,264	157 x 110
UNXBP422-8	+5 +/-12	330 46	1,65 0,552	203 x 157
UNXBPMR-8 with 8 MR400ISO	NC	NC	NC	225 x 116
UNXBPMR-8 with 8 MR232ISO	NC	NC	NC	225 x 116

Relative Humidity	Operating temperature in °C	Storage temperature in °C
95 % at +25°C	-5°C to +65°C	-25°C to +70°C